

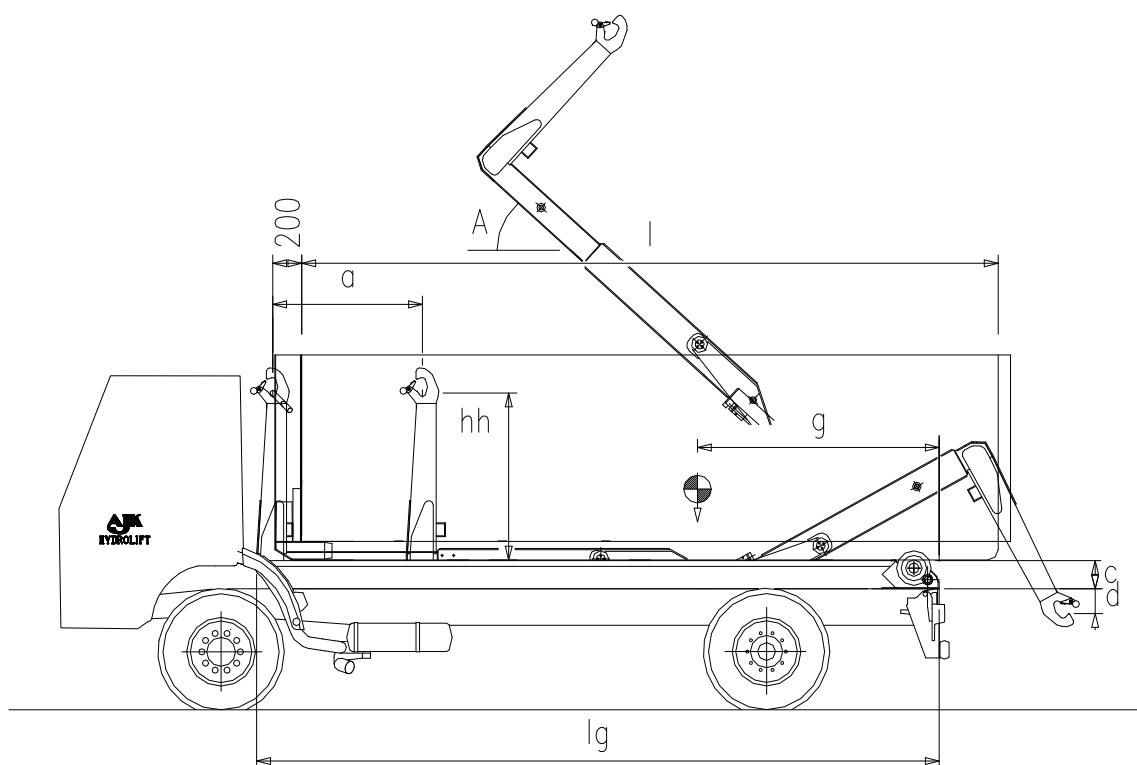

01-06-2007

# NHS-16



Length	Stroke	Bin length
4480	900	3300-4500-(5000)*
4680	900	3500-4750-(5250)*
4930	1025	3600-5000-(5500)*
5180	1100	3800-5250-(5750)*
5430	1100	4000-5500-(6000)*
5760	1300	4250-5750-(6250)*
5930	1300	4500-6000-(6500)*
6180	1400	4750-6250-(6750)*
6430	1400	5000-6500-(7000)*

The constructor has the right to make modifications without prior notice